

Y Pwyllgor
Cynllunio

Planning
Committee

22.09.2020

**RHANBARTH
Y DE**

**AREA
SOUTH**



EICH CYNGOR arleinamdani
www.sirgar.llyw.cymru

YOUR COUNCIL doitonline
www.carmarthenshire.gov.wales

Y Pwyllgor
Cynllunio

Planning
Committee

**EITEM ER
GWYBODAETH**

**INFORMATION
ITEM**



EICH CYNGOR arleinamdani
www.sirgar.llyw.cymru

YOUR COUNCIL doitonline
www.carmarthenshire.gov.wales

Y Pwyllgor
Cynllunio

Planning
Committee

DNS/00422



EICH CYNGOR arleinamdani
www.sirgar.llyw.cymru

YOUR COUNCIL doitonline
www.carmarthenshire.gov.wales

DNS/00422

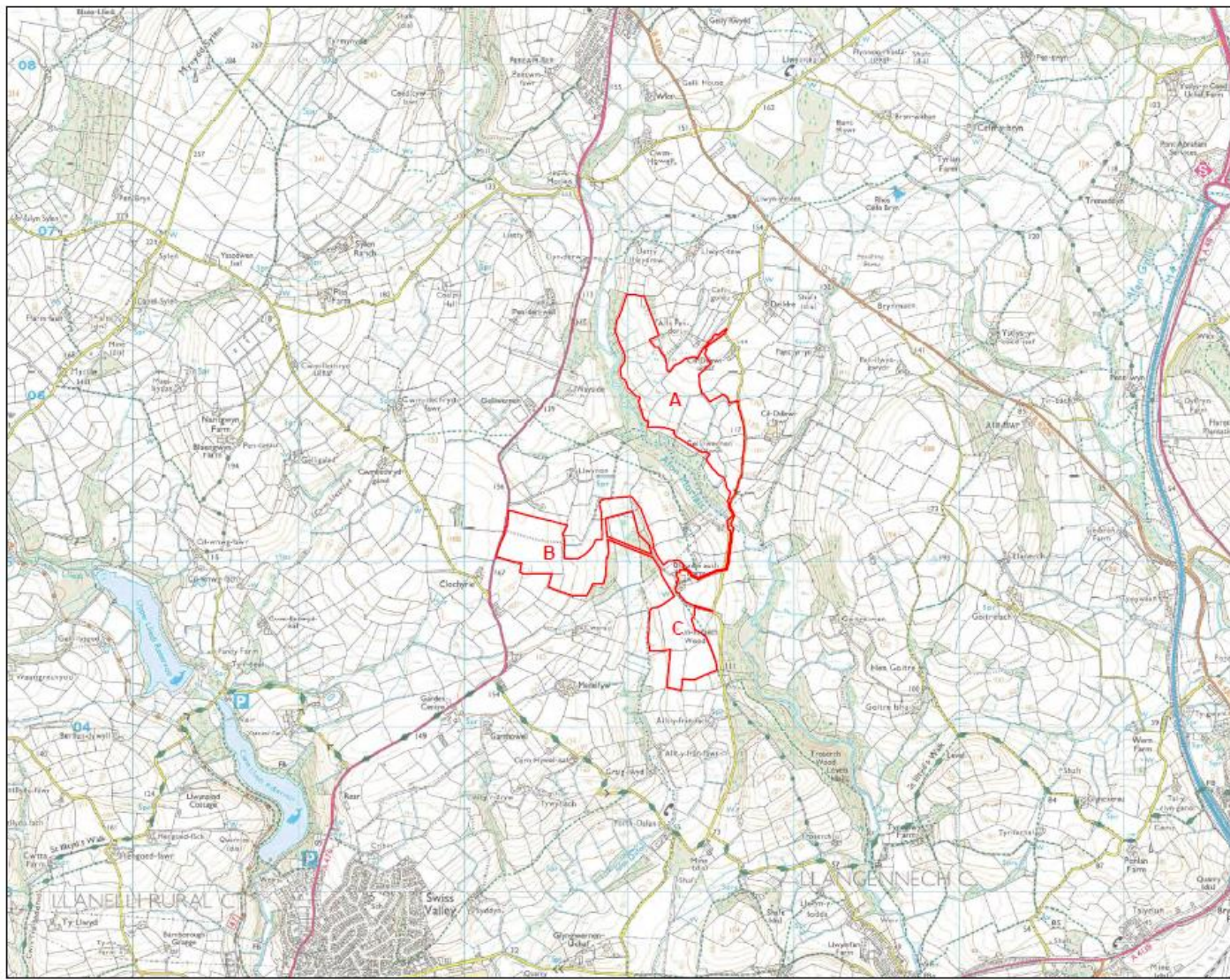

KEY
[Red outline] Site Boundary



Information based on all known constraints.
© Crown copyright. All rights reserved. 2014 Emapdata Licence number 0100051673. Ordnance Survey Copyright Licence number 100042093. Promap Licence number 100020449

6.1 | FIGURE

Site Location Plan | TITLE

1:25,000 @ A3 | SCALE
BRS.4254_22-B | DWG. NO.

DNS/00422

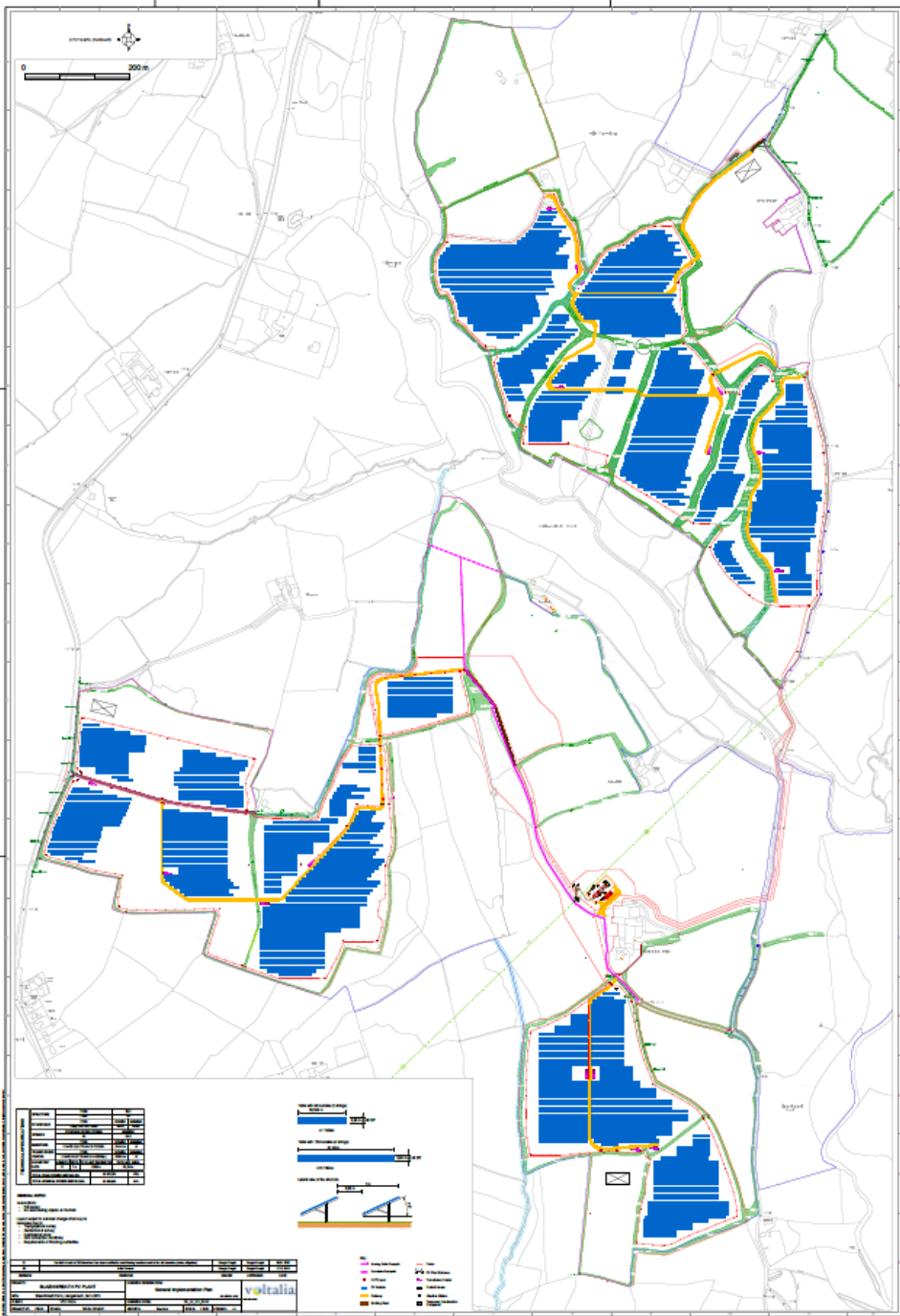

DNS/00422

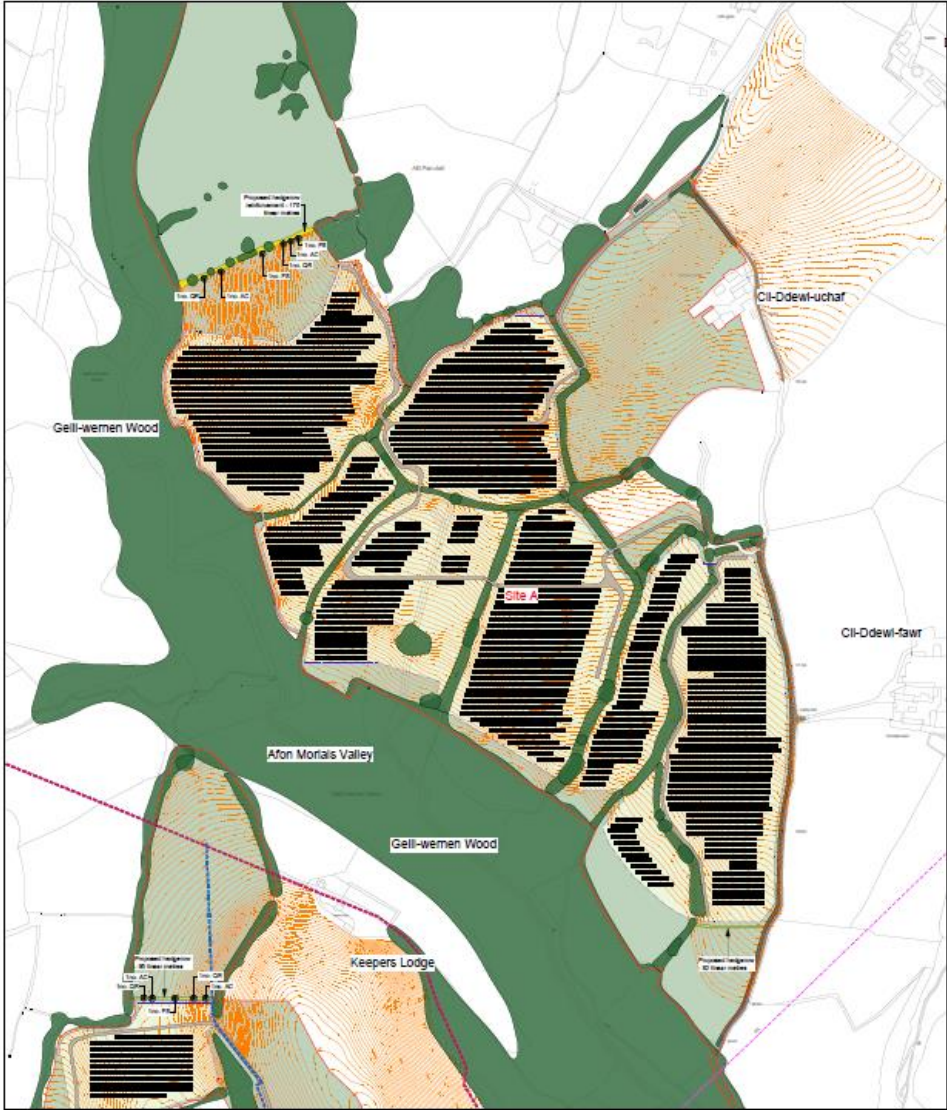

- KEY**
- Site Boundary
 - Contours
 - Public Right of Way
 - Permitted Footpaths
 - Proposed Security Fence
 - Solar Panels
 - Transmission Site
 - Other Proposed Works
 - Existing Turf
 - Existing Wood and Hedgerow and Trees
 - Proposed Hedgerow and Field Boundary
 - Proposed Hedgerow (to be replaced)
 - Proposed New Tree
 - Temporary Closed to Site or Compensated
- 0 10m

FIGURE 6.2
 Site A - Site Layout and Landscape Framework
 COWI WULFJON & CO
 Date: 2018-08-08
 Scale: 1:500

DNS/00422



- KEY**
- Site Boundary
 - Contours
 - Public Right of Way
 - Permissive Footpath
 - Gas Pipelines
 - Proposed Security Fence
 - Solar Panels
 - Transformer Box
 - Overhead Power Lines
 - Access Track
 - Temporary Construction Compound
 - Existing Woodland, Hedgerows and Trees
 - Proposed Hedgerow Reinforcement
 - Proposed Hedgerow (double staggered row)
 - Proposed Native Tree

FIGURE 6.2
Site B - Site Layout and Landscape Framework
© 2019 by B&B, 42/21, 15/11/19
 Date: 15/1/2019 Sheet No: 04
 Scale: 1:500 8A1

DNS/00422

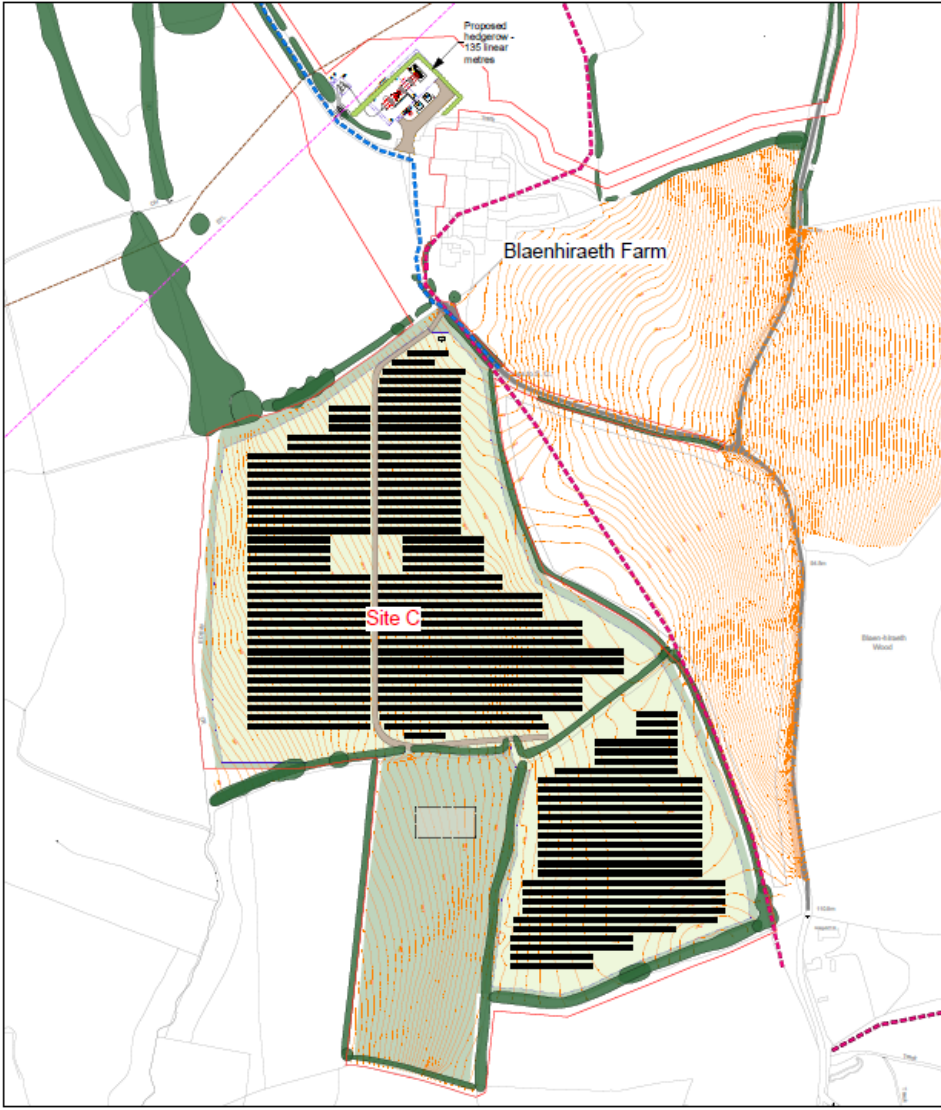

KEY

Site Boundary	Proposed Hedgerow
Contours	Temporary Construction Compound
Public Right of Way	
Proposed Hedgerow	
Proposed Boundary Line	
Site Fences	
Transformer Site	
Overhead Power Lines	
Access Tracks	
Existing Woodland, Hedgerows and Trees	
Proposed Hedgerow	
Proposed Hedgerow	

FIGURE 4.2
 Site C - Site Layout and Landscape Framework
 DNS/00422
 Scale: 1:500

DNS/00422



Existing flat structure on site

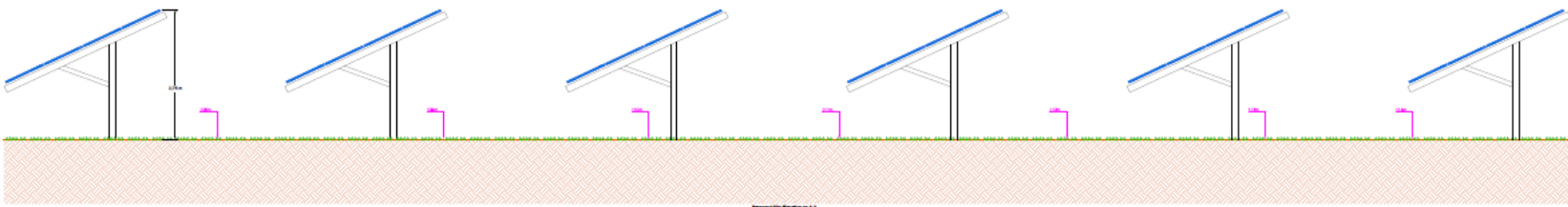

Proposed flat structure on site

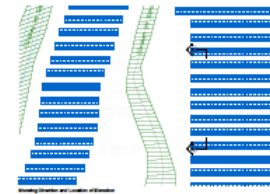

NO	DESCRIPTION	DATE	BY	CHECKED
1	Issue for tender	2023/08/01
2	Issue for construction	2023/08/01
3	Issue for completion	2023/08/01

Client: Woolston Park	Project: Woolston Park
Site: Woolston Park, Wellington	Phase: Final
Scale: 1:100	Author: ...
Drawn: ...	Checked: ...
Approved: ...	Project Manager: ...

Existing + Proposed Elevations

DNS/00422

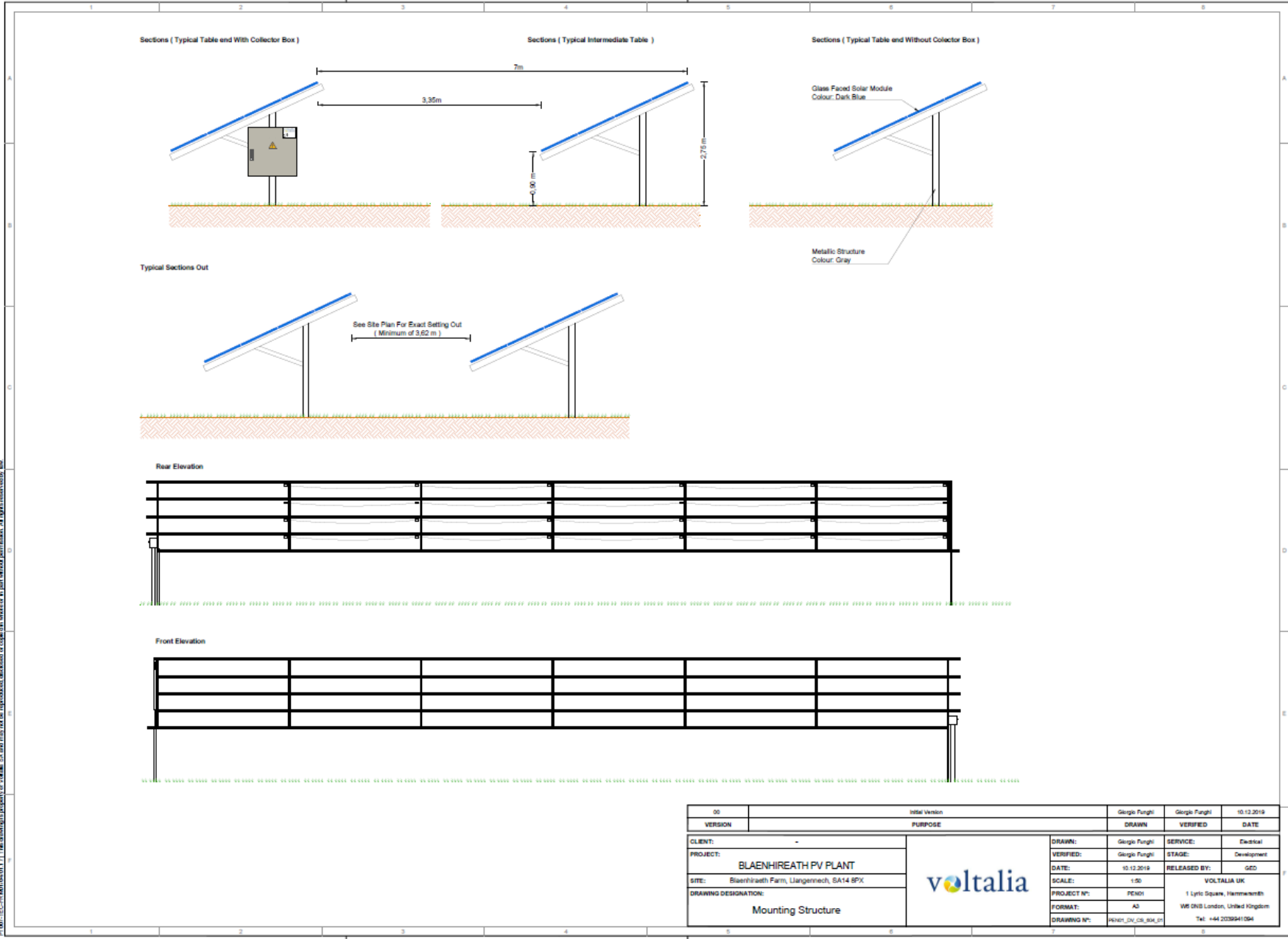

00017522-00-0001-0001-17 This drawing is property of VOLTAIA UK and may not be reproduced, stored or copied in any form without permission. All rights reserved.

00	Initial Version	Georgio Fungli	Georgio Fungli	10.12.2019	
VERSION	PURPOSE	DRAWN	VERIFIED	DATE	
CLIENT:	-	DRAWN:	Georgio Fungli	SERVICE:	Electrical
PROJECT:	BLAENHIREATH PV PLANT	DATE:	10.12.2019	STAGE:	Development
SITE:	Blasbriarth Farm, Llanermech, SA14 8PX	SCALE:	1:50	RELEASED BY:	GED
DRAWING DESIGNATION:	Mounting Structure	PROJECT N°:	PEM01	VOLTAIA UK	
		FORMAT:	A2	1 Lyric Square, Hammarbyhögskolan, SE-141 86 Nacka, Sweden	
		DRAWING N°:	PEM01_001_001_001_01	WS DNS London, United Kingdom	
				Tel: +44 203641094	



DNS/00422

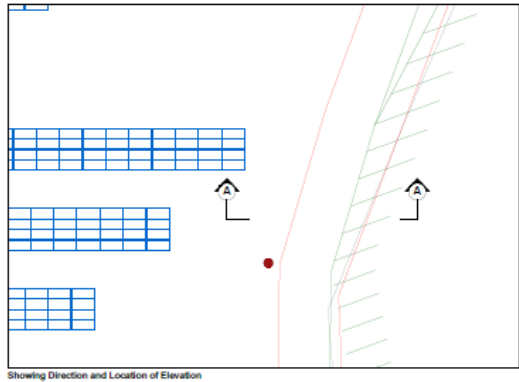
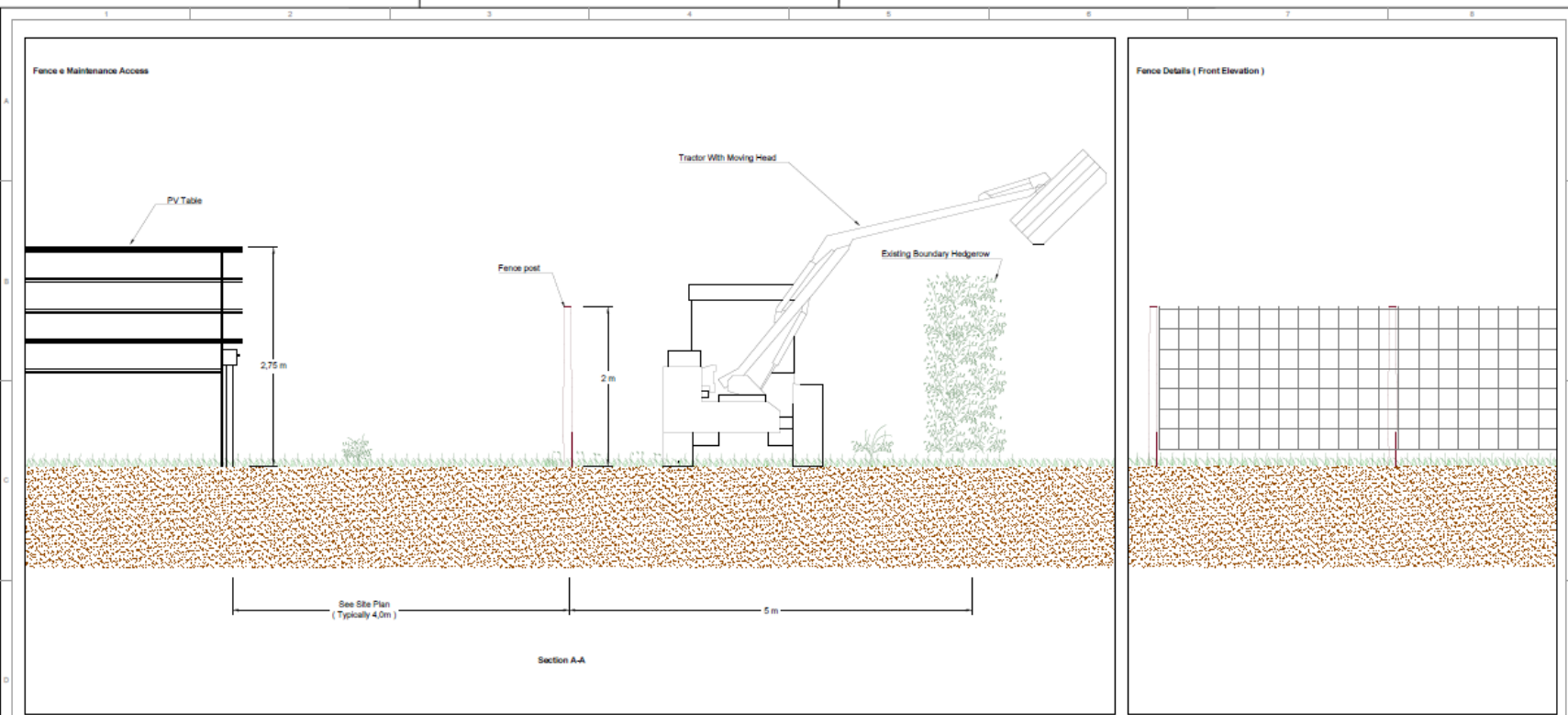

00	Issue Version	George Fungli	George Fungli	10.12.2019
VERSION	PURPOSE	DRAWN	VERIFIED	DATE
CLIENT:		DRAWN:	SERVICE:	Electrical
PROJECT:	BLAENHIREATH PV PLANT	VERIFIED:	STAGE:	Development
SITE:	Blaenhireath Farm, Llansamlet, SA14 8PX	DATE:	RELEASED BY:	GED
DRAWING DESIGNATION:	Mounting Structure and Fence Detail	SCALE:	VOLTALIA UK	
		PROJECT N°:	1 Lytch Square, Hammersmith	
		FORMAT:	W8 DNS London, United Kingdom	
		DRAWING N°:	Tel: +44 203941094	

PROTECTED BY PATENT | The drawing is the property of voltalia. It and its contents are reproduced without or copyright reserved. All rights reserved.

DNS/00422

Security Fencing (Front Elevation)

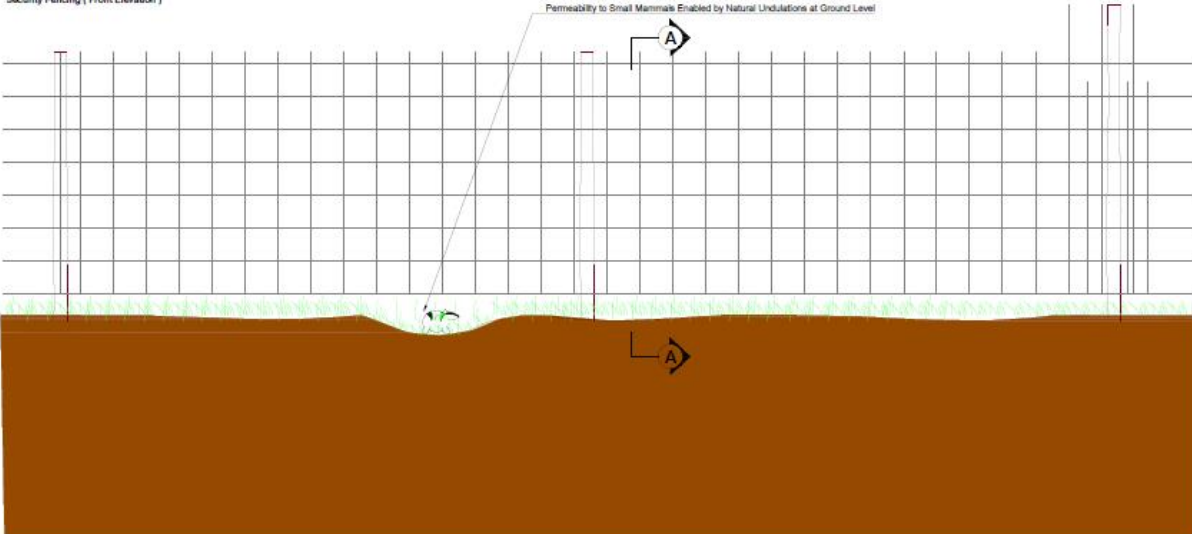

Security Fencing (Section A-A)

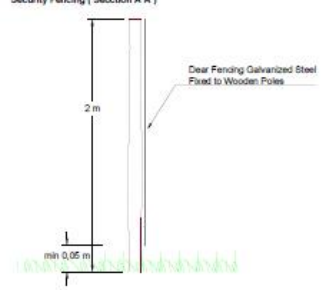

Security Fencing (Sample Images)



PROJECT: DNS/00422 (DNS/00422) | The drawings are the property of VOLITALIA UK and may not be reproduced, distributed, copied, distributed, or otherwise used without permission. All rights reserved.

00	Initial version	George Fungit	George Fungit	10.12.2019	
VERSION	PURPOSE	DRAWN	VERIFIED	DATE	
CLIENT:	-	DRAWN:	George Fungit	SERVICE:	Electrical
PROJECT:	BLAENHIREATH PV PLANT	VERIFIED:	George Fungit	STAGE:	Development
SITE:	Blaenhireath Farm, Llangennech, SA14 8PX	DATE:	10.12.2019	RELEASED BY:	GED
DRAWING DESIGNATION:	Fence Details	SCALE:	1:50	VOLITALIA UK	
		PROJECT N°:	FCN01	1 Lyric Square, Harmerweth	
		FORMAT:	A3	WR 0N3 London, United Kingdom	
		DRAWING N°:	HN01_DNS_00422_00	Tel: +44 2039441084	



DNS/00422

PT007-TEC-FRM01/03/09.16 | This drawing is property of Voltalia SA and may not be reproduced, disclosed or copied in whole or in part without permission. All rights reserved by law.

Transformer Station (Front Elevation)
Scale: 1:70

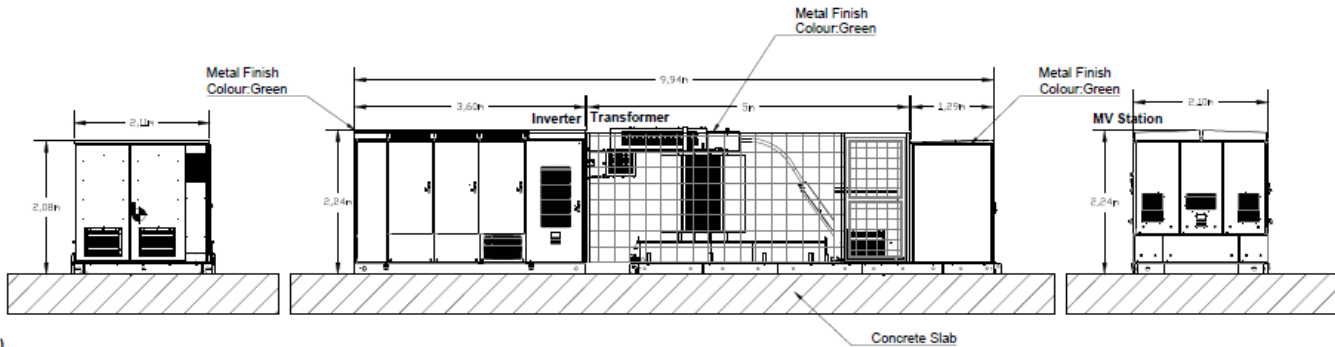

Transformer Station (Plant)
Scale: 1:70

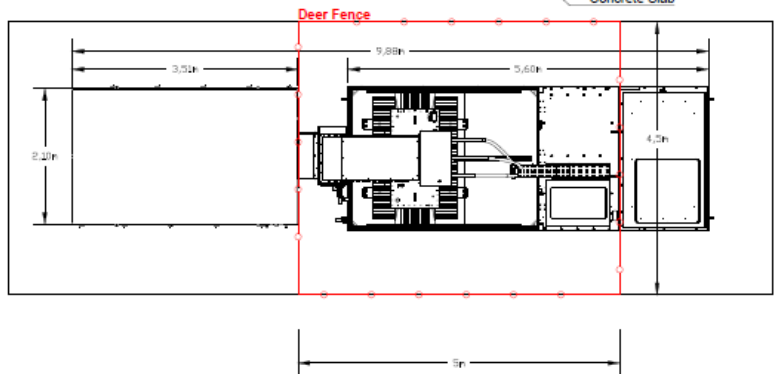

00	Initial version	Giorgio Funghi	Giorgio Funghi	10.12.2019	
VERSION	PURPOSE	DRAWN	VERIFIED	DATE	
CLIENT:	-	DRAWN:	Giorgio Funghi	SERVICE:	Electrical
PROJECT:	BLAENHIREATH PV PLANT	VERIFIED:	Giorgio Funghi	STAGE:	Development
SITE:	Blaenhiraeth Farm, Llangennech, SA14 8PX	DATE:	10.12.2019	RELEASED BY:	GED
DRAWING DESIGNATION:	Transformer Center Connection Details	SCALE:	1:100	VOLTALIA UK	
		PROJECT N°:	PEN01	1 Lyric Square, Hammersmith	
		FORMAT:	A4	W6 0NB London, United Kingdom	
		DRAWING N°:	PEN01_DV_HV_120_00	Tel: +44 2039941094	



DNS/00422

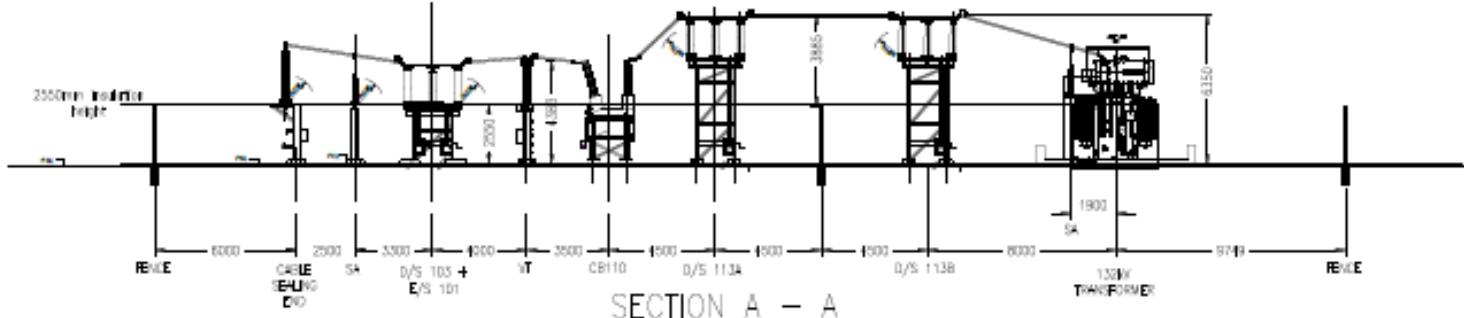

SECTION A - A

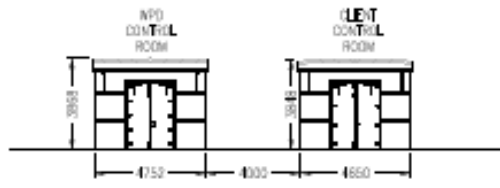

SECTION B - B

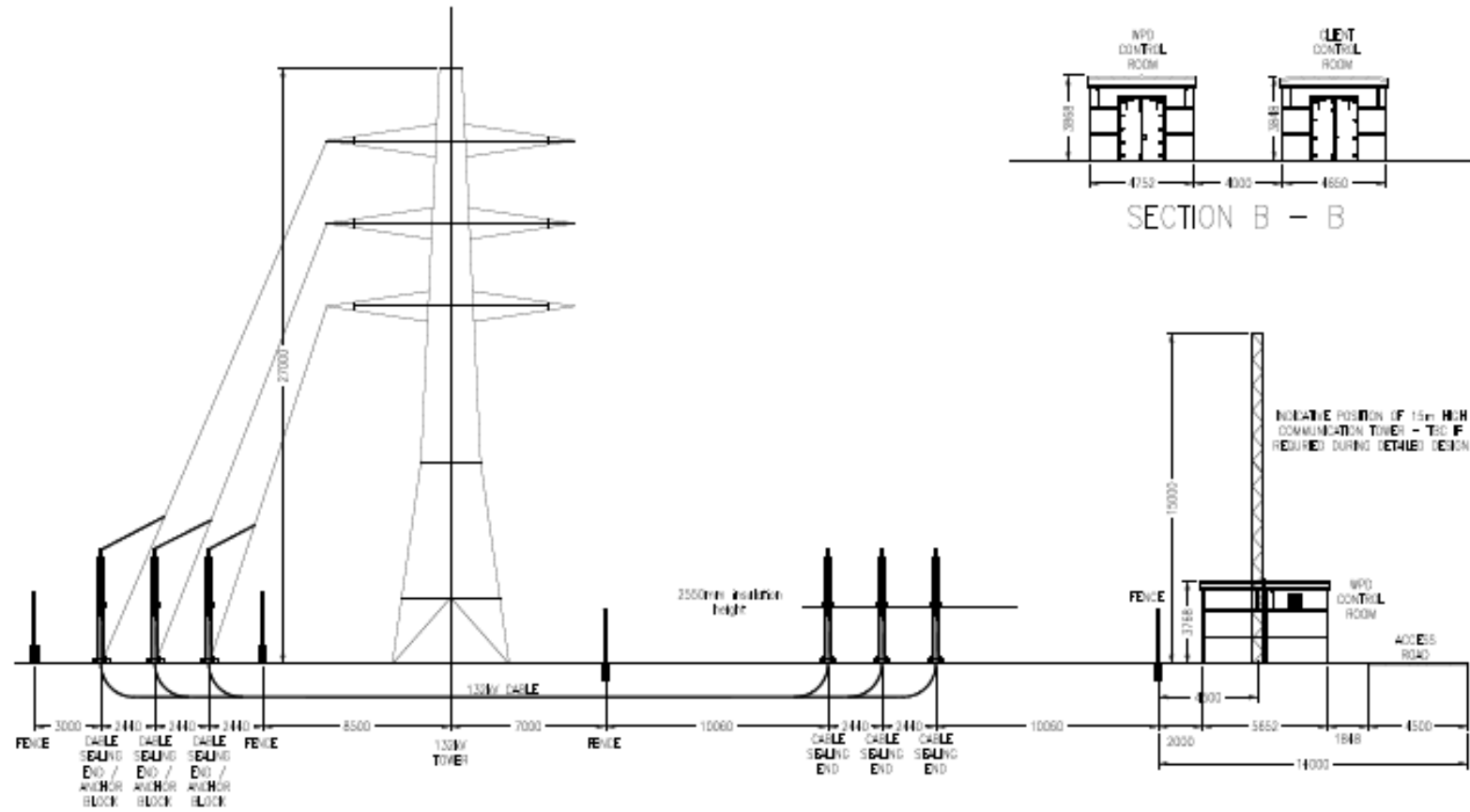

SECTION C - C

DNS/00422

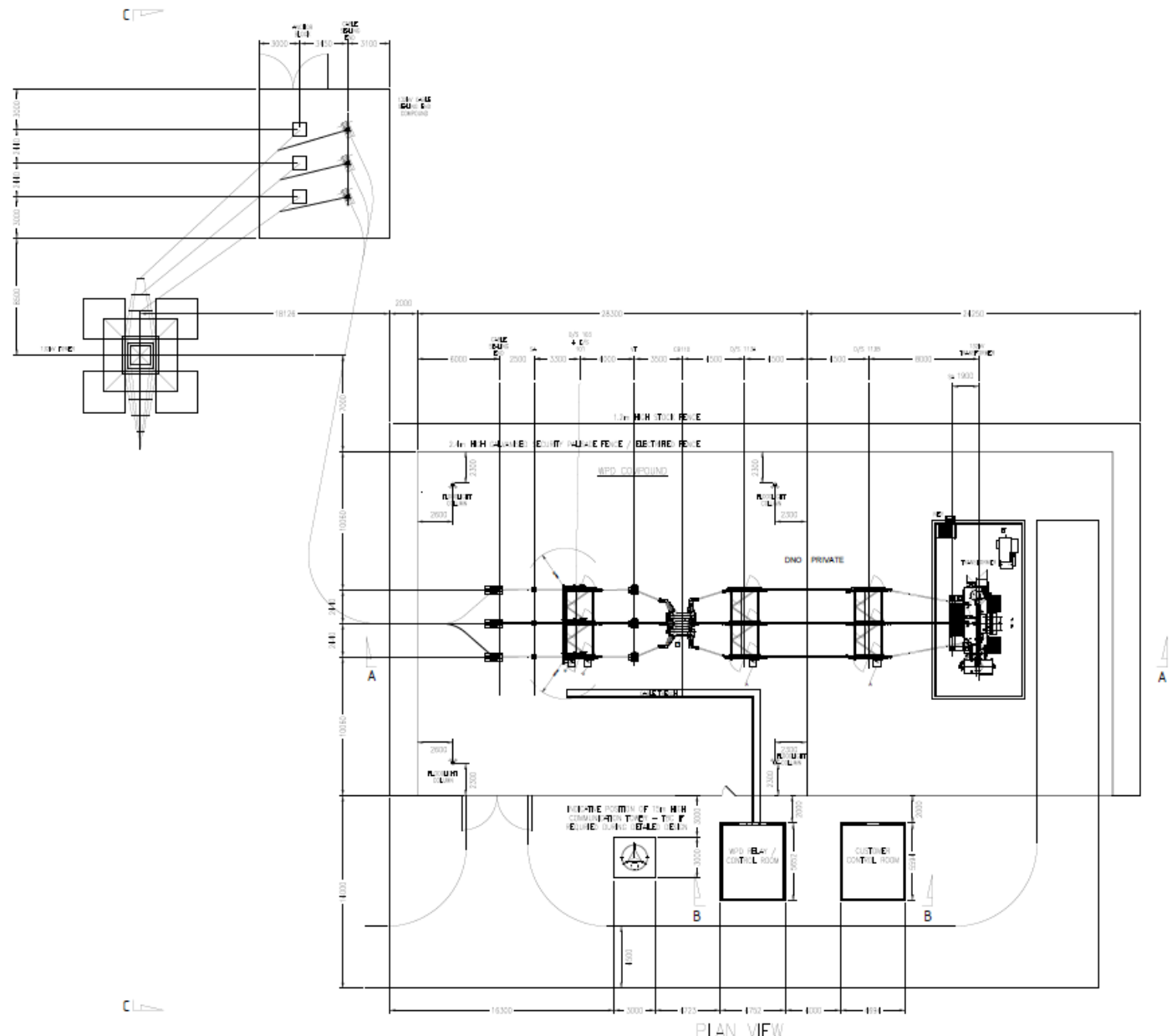

DNS/00422

CCTV Camara (Elevation)

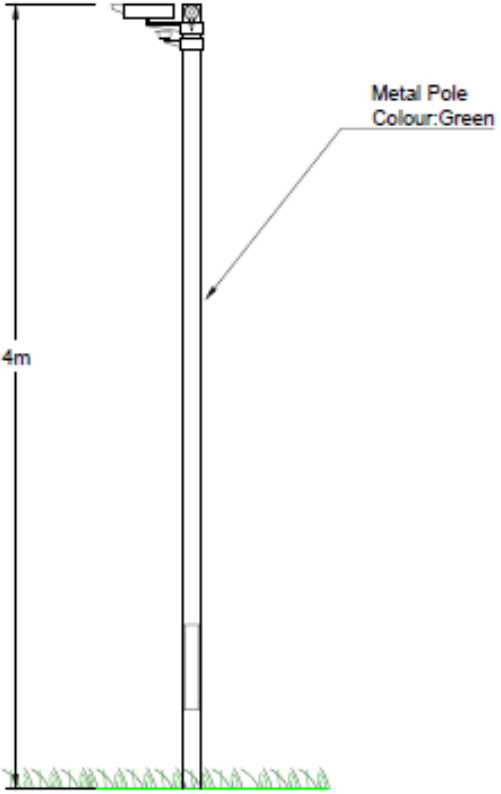

Control House (Front Elevation)

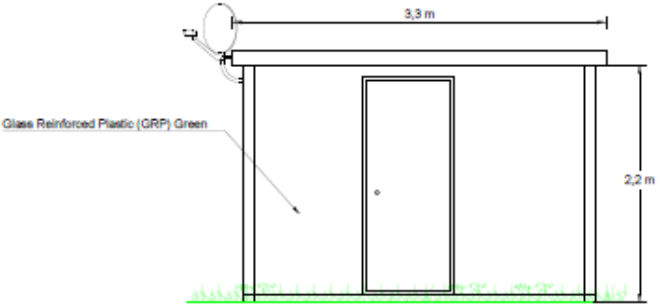

Control House (Side Elevation)

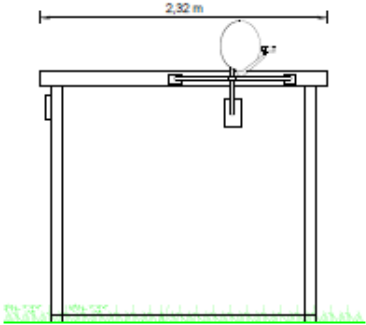

Control House (Rear Elevation)

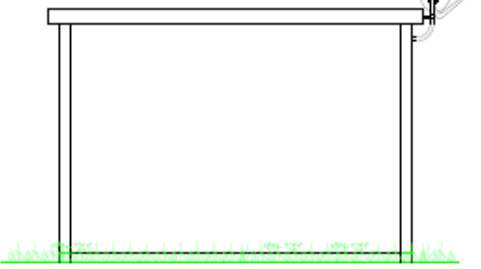

Control House (Roof Plan)

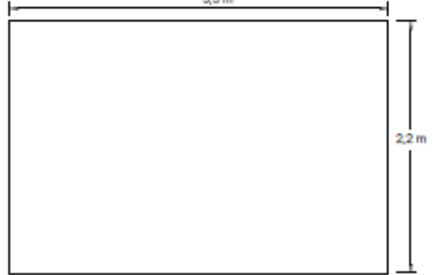

DNS/00422

Meteo Station (Elevation)

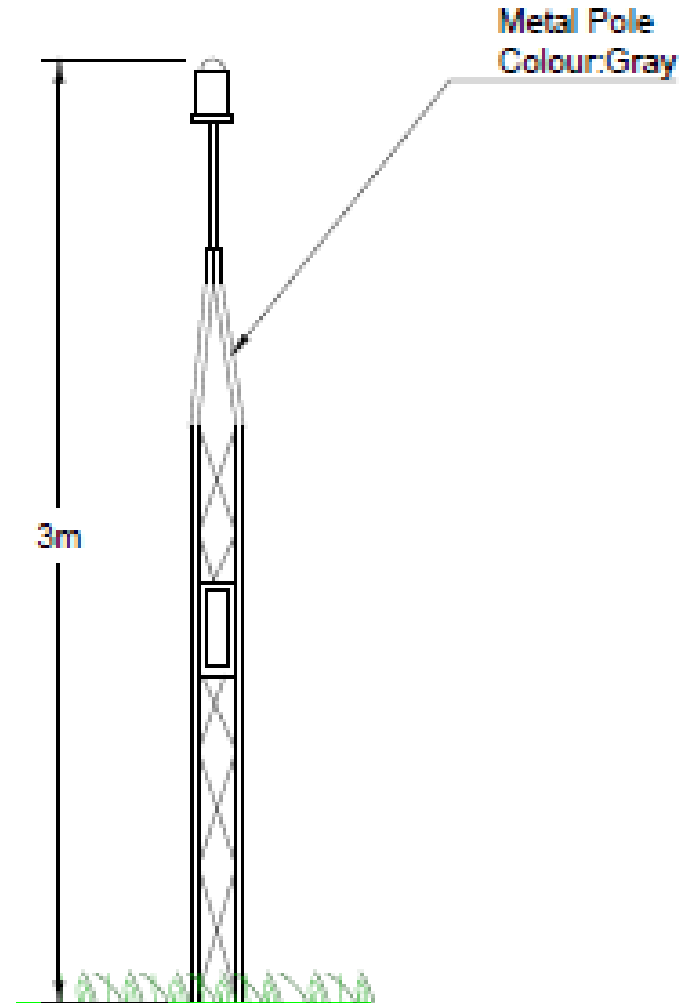



Camera make & model - Canon EOS 5D, FPS
Lens make & focal length - Canon EF 50mm, f/1.4 USM
Date & time of photograph - 23/10/2019 @ 13:31
OS grid reference - 254155, 205533

Viewpoint height (AOD) - 113.2m
Distance from site - 74.4m
Projection - Planar
Enlargement / Sheet Size - 100% @ A3

Visualization Type - Type 1
Horizontal Field of View - 39.6°
Height of camera AGL - 1.5m
Page size / Image size (mm) - 420 x 297 / 390 x 260

Existing View 3. Keepers Lodge

DNS/00422



DNS/00422

58



Camera make & model - Canon EOS 5D, FF5
Lens make & focal length - Canon EF 50mm, F1.4 USM
Date & time of photograph - 08/08/2019 @ 11.44
OS grid reference - 253545, 204551

Viewpoint height (AOD) - 149.2m
Distance from site - 383.4m
Projection - Planar
Enlargement / Sheet Size - 100% G A3

Visualisation Type - Type 1
Horizontal Field of View - 39.4°
Height of camera AGL - 1.5m
Page size / Image size (mm) - 420 x 297 / 390 x 260

Existing View
12. Penderi Farm

DNS/00422



DNS/00422

94



Camera make & model - Canon EOS 5D, FFS
Lens make & focal length - Canon EF 50mm, f/1.4 USM
Date & time of photograph - 08/08/2019 @ 11:08
OS grid reference - 253609, 204186

Viewpoint height (AOD) - 139.3m
Distance from site - 581.3m
Projection - Planar
Enlargement / Sheet Size - 100% @ A3

Visualization Type - Type 1
Horizontal Field of View - 39.6°
Height of camera AGL - 1.5m
Page size / Image size (mm) - 420 x 297 / 390 x 260

Existing View
20. Medelfwy Farm



DNS/00422

